

## Шлицевая втулка

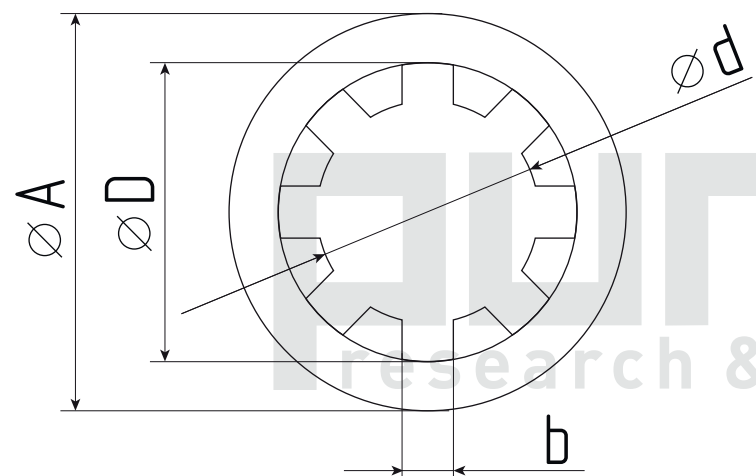
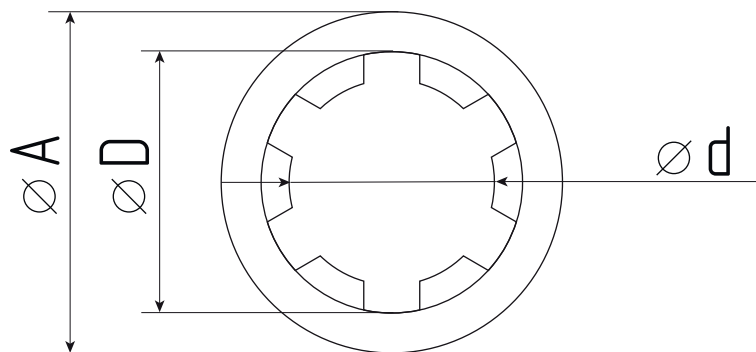

Артикул	d(mm) H7	D(mm) H11	A(mm) H11	b(mm) H9	Кол-во зубьев	Длина(mm)
SN-11x14	11	14	30	3.0	6	50
SN-13x16	13	16	29	3.5	6	40
SN-16x20	16	20	39	4.0	6	40
SN-18x22	18	22	40	5.0	6	60
SN-21x25	21	25	44	5.0	6	65
SN-23x28	23	28	44	6.0	6	50
SN-26x32	26	32	49	6.0	6	50
SN-28x34	28	34	54	7.0	6	50
SN-32x38	32	38	64	6.0	8	65
SN-36x42	36	42	74	7.0	8	100
SN-42x48	42	48	74	8.0	8	100