



**РУКОВОДСТВО
ПО ЭКСПЛУАТАЦИИ
КОНТРОЛЛЕРА
ТНС СНС-1000L**

Laser Cutting Height Controller

Auto Focus System

(Model: CHC-1000L)



2016/2/18

Please read this manual fully before you start installation work.

1. Brief introduction

CHC-1000L is a closed-loop controller for laser cutting height control(called Auto focus system in laser cutting field). By providing a unique Ethernet communication(TCP/IP protocol) interface, it can support many functions with CNC controller for laser cutting, such as automatic tracking of cutting height, segmented piercing, progressive piercing, edge seek, leapfrog, arbitrary setting of lift-up height of cutting head.

Thanks to our years experience of different kinds of torch height controller design, Currently CHC-1000L should have better response rate than other similar products.

Performance Description

- Sampling rate: 1000 times per second.
- Static measurement accuracy: 0.001mm.
- Dynamic response accuracy:0.05mm.
- Following range: 0-25mm.
- The signal will not decay with strong capacity of resisting when the length of signal transmission cable is up to 100m.
- Support network communications and U disk online update.
- Adapt to any cutting head and nozzle.
- Support alarm while hitting the board and beyond the edge.
- Support edge detection and automatica inspection.
- Automatic calibration process, with fast and easy operations.
- Support leapfrog and segmented piercing.
- Support oscilloscope functions to detect the capacitance in real time.

Comparison of CHC-1000L and other height control product.

Specs	Other controller	CHC-1000L
Max moving speed	400mm/s	999mm/s
Max acceleration	0.4G	2G
Capacitance Mutation Restraint	5%	10%
Min Inflexibility Requirement	5Hz	2Hz
DA resolution	12 bit	16 bit
DA zero drift	16mv	3mv
DA response time	5ms	0.01ms
Positioning accuracy	0.05mm	0.01mm

2. Operation instruction

2.1 Keys on operation panel

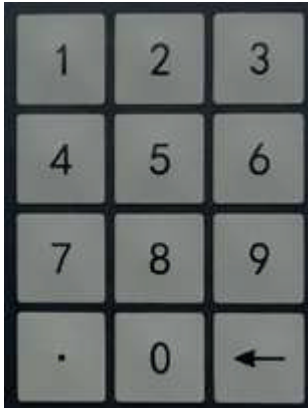

for digital input and parameter input



SHUT: The cutting head will automatically rise to the stop position while shutting the follower.

FOLLOW: Open the following function.

FAST and SLOW: Used for adjusting the following gain level.

+0.1 and -0.1: Used for adjusting the following height.

STOP: Immediately stop all movements.

HOME: origin position. Immediately go back to the origin and correct mechanical coordinates.

SHF: arrow key, for switching cursor and inching follower, the SHF key can switch the jog speed.

ENTER: Confirm the current operation.

ESC: Cancel the operation and go back.

2.2 Software function introduction graph

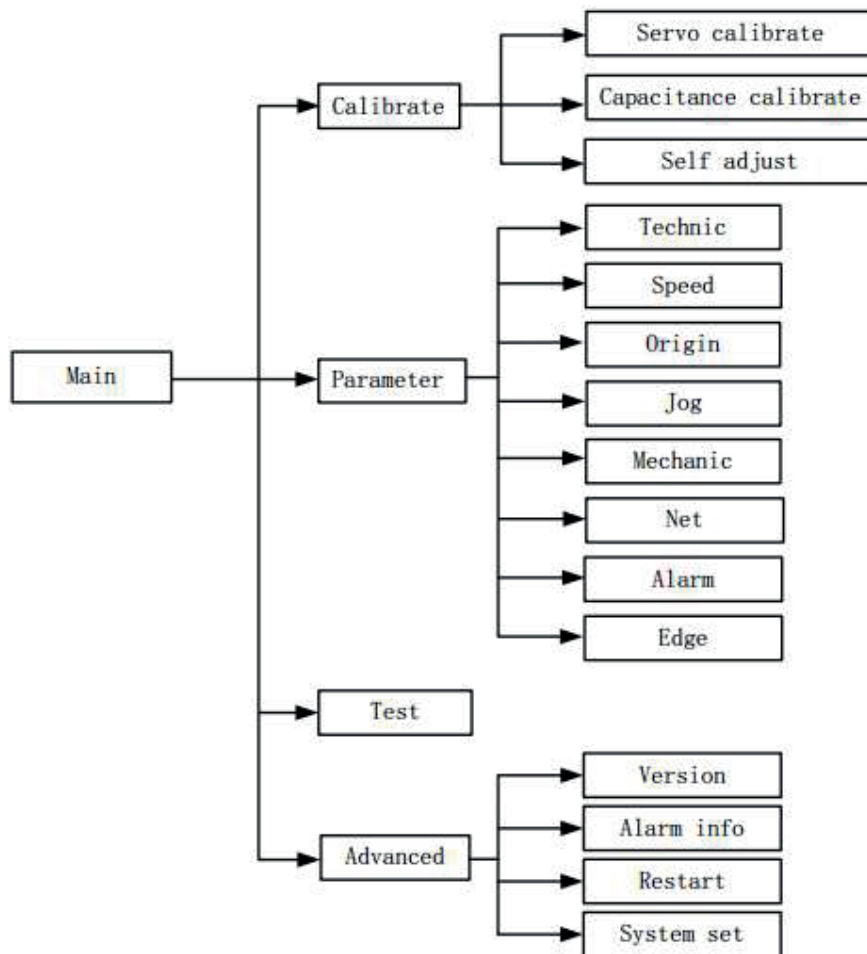

2.3 Main Interface of software

CHC-1000L will automatically enter (main interface) after the system is powered on and the initialization is completed, as shown below,

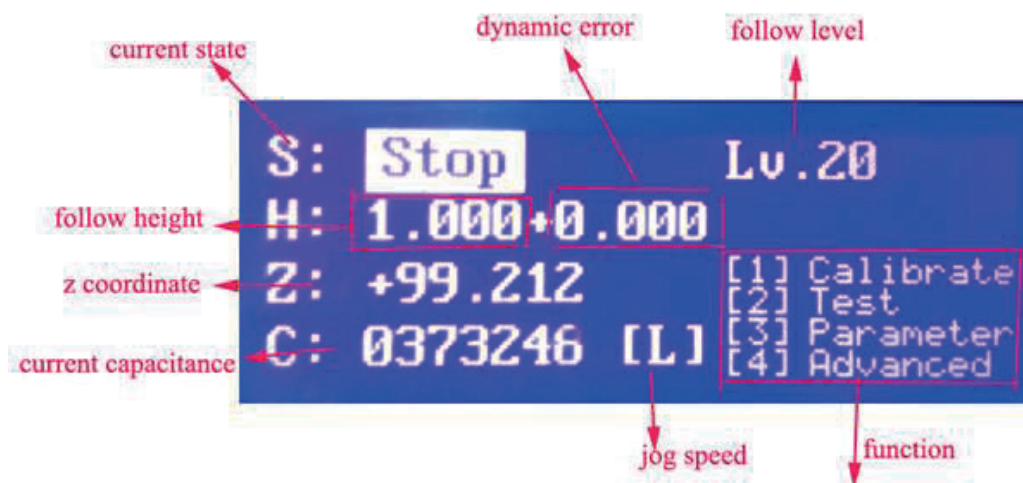

The display on the main interface include,

Current status: display the current motion state of the height controller. The motion states as follow,

- A. Stopped: Z axis is in an idle state.
- B. Decel: there will be a very short transition state for slow stop after receiving a stop instruction in motion state. It will change into Stop state after complete stop.
- C. Moving: It is the movement of Z axis while lifting up during processing.
- D. Follow: The follower follow the board while conduct pierce and cutting operations.
- E. Origin: Go back to the mechanical origin of z axis.
- F. Jogging: Manually jog z axis
- G. Lift up: It is the process to shut the follower off, and lift it to the stop position.
- H.

Following gain level:

The level of following again ranges from 1 to 30. The large level is , the smaller average error is, the quicker follow acts, and the stronger slope move ability is, But if gain is too high, there maybe self-oscillation. It is recommended to set this parameter by self adjustment.

Following height:

The actual following height can be adjusted with a step of 0.1mm after pressing the button +0.1 or -0.1. The following mode can be changed through press SHUT and FOLLOW. After press SHUT, the axis will automaticall raise to the stopping coordinates(if defaults to the position of z-0; the stopping coordinates can be modified after press F2 to enter the parameter interface. In addition, in the Ethernet control mode, the following height is set by Cypcut software.

Dynamic error: In the following state, this value reflects the real time error during following movement.

Distance H between follower and the board surface: Within the capacitance measurement range(calibration range), the distance between follower and the board surface is following height plus dynamic error. When exceeding the measuring range, set following height plus dynamic error is identically equal to the calibration range.

Current Z axis coordinates: After homing to origin, a mechanical coordinatte system is established at z axis, the coordinate will increase when moving down.

Current capacitance value C: The principle of systematical sampling is to get the distance through measuring the capacitance between the follower and polar plate.

The closer the follower is to the board, the bigger the capacitance value is. The capacitance will change to zero while the follower hits the board.

Jog speed of z axis: L represents low jog speed and the H represents high jog speed. The jog speed stalls can be switched through press the button SHF. You can press the arrow button to jog.

2.4 Calibration Interface

In the main interface, press the key 1 to enter calibration interface, as shown below,

```
[1] Capacitance calibrat
[2] Servo calibrate
[3] Self adjustment
```

After CHC-1000 was installed and sued as first time, do servo calibration first. Then return origin, do capacitance calibration. At last, do self adjustment. At the next time, do capacitance calibration is enough.

2.4.1 Capacitance calibration

The purpose of follower calibration is to measure the corresponding relationship of capacitance and position between follower and board. Press<1> to enter the interface of <follower calibration>, as follow,

```
Please jog to approach the board
Keep board static,no vibration.
Z:+001.11 Low
C:00320000 [F4] SET
[ENT]START
```

If no setting has been conducted before, press 4 to set calibrated parameters.

```
Calibrate Distance 17.0 mm
Board material:
[F1] metal [F2] nonmetal
[ENT]save
```

Parameter	Description
Calibration distance	Record the capacitance data within the range for calibration, the default is 25mm. When the travel of z axis is too short, users can reduce the value accordingly.

Board material	Set the material of the following object.

Press <Enter> to save the parameters and return to the previous interface. Before calibration, first jog the follower and make it close to the board(larger than 1mm from the board), and keep the board still without vibrations. Then press <enter> to begin calibration.

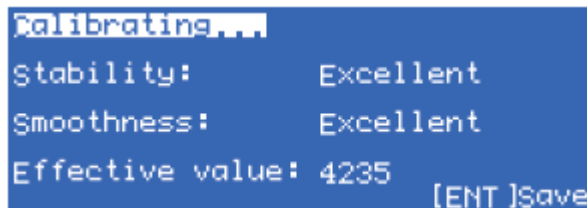

```

Calibrating...
Stability:      Excellent
Smoothness:    Excellent
Effective value: 4235
[ENT] Save

```

The calibration process can be done automatically within ten seconds. Users can press the <stop> button to forcibly terminate the calibration. After the calibration is complete, there are two standards, and four grades of < excellent, good, not good, poor> are respectively set for each standard. The automatic calibration steps are as follow,

1. Head moves down slowly and checks if board is hit.
2. After head hits the board, moves up for 2mm, checking the stability.
3. Head moves down slowly and checks if board is hit for the second time.
4. If board is hit, head moves up for the calibrate range, checking the smoothness and the capacitance characteristic.

If one of the steps is not executed, and there is alarm after calibration, hardware or connection problem should be considered. And easy way to check the problem is: touch the spray by metal and see if capacitance changes. If the change is low<in 200> or the capacitance is always 0, hardware or connection problem is proved. In addition, considered to safe and static electricity factor, touch the spray by hand when system is powered is not suggested.

The meaning of calibration result is as follow,

Stability: It means the static characteristics of the capacitance. If the standard is not ideal after calibration, the reason may be due to the vibration of the board or strong external interference.

Smoothness: It means the dynamic characteristics of the changes in capacitance during calibration.

These two standards at least should be <medium>, or the system may not be able to be used normally. In relatively ideal conditions, the two standards should be <excellent> or <good>.

Effective value: It's difference of capacity from 0.5mm nearby board

to infinity. If the value is large, follow precision and stability is better.

After press <enter> to save the calibration results, capacitance distance curve will be displayed. Normal curve should be smooth, as follow,



If the curve is not smooth with downs or glitches, the results are not ideal and re-calibration is needed. If the results are still not ideal after repeated calibration, users should re-check the hardware installation and wiring of the system.

And , users can view the calibrated curve after press button <6> on main interface.

If Calibration failed, alarm shown as follow,

Alarm	Description
Hit board over time	When calibrating, if cutting head moves down and check no board is hit in long time, there will be this alarm. How to check what happened? 1. Ensure the head is near the board before calibration< around 5mm>. 2, check if the hardware and connection are right. 3. Try calibration again. If head not move when calibrating, maybe the resolution ratio of analog voltage output is not enough. You should try to modify the speed voltage gain less.
Leave board overtime	Check if the hardware and connection are right
Sample overtime	Do calibration again
Always hit board	Refer to Leave board overtime alarm.
Capacity changes abnormally	Do calibration again. Take care of jog near the board at about 1—5mm before calibration.

2.4.2 Servo calibration.

The purpose of servo calibration is to eliminate the zero drift of servo motor. Press the key 2 to enter the interface of <servo calibration>, as below,

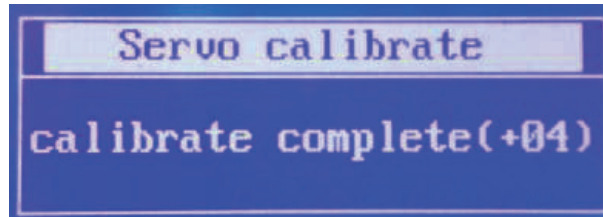

During servo calibration, the motor vibrates back and forth with small amplitude, so it is required to first jog the motor to the mid-tavel, thus prevent from exceeding the travel range while vibrating. Then press<enter> to begin calibration.

The system will return to the previous interface after completing the automatic calibration.

2.4.3 Self adjustment

Press <3> enter the interface of Self adjustment, as follow,

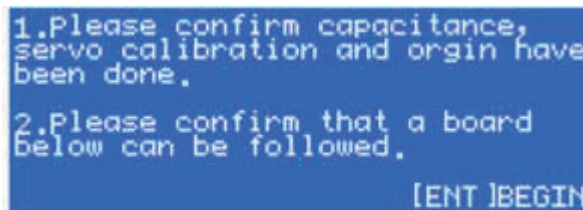

2.5 Test Interface

On the main interface, press <2> to enter the interface of <function test>, as follow,



User can test the state of keys, input and output ports and the rotation direction of motor are correct. **After completing the installation at the first time, user must enter the interface for switch jog to determine whether the rotation direction of motor and the director of encoder signal are correct or not. If the rotation direction of motor is incorrect, users need to modify the servo direction parameters in mechanical parameters.** And then conduct open-loop jog to determine whether the direction of encoder signal is correct. If it is promoted that the direction of encoder is incorrect, user needs to modify the encoder direction parameters in mechanical

parameters.

The input and output ports of the interface defined as follow,

Input port	Definition	Output port	Definition
IN1	Follow to cutting height	OUT1	Signal for following to place
IN2	Move to aligning coordinate	OUT2	Stay to position signal
IN3	Lift-up signal	OUT3	Alarm output signal
IN4	Stopping signal	OUT4	Punching signal
IN5	Negative limit	OUT5	Servo clearing alarm (servo signal)
IN6	Positive limit	OUT6	Servo enabled (servo signal)
IN7	Servo alarm (servo signal)	OUT7	Zero speed clamp (servo signal)

2.6 Parameter Interface

On main interface, press 3 to enter parameter interface, as follow,

```
[1] TECHNIC [5] MECHANI
[2] SPEED   [6] NETWORK
[3] ORIGIN  [7] ALARM
[4] JOG     [8] EDGE
```

Users must correctly set the parameters above when use CHC-1000 for the first time. Especially the Mechanical parameters should be set right, or the system can not work well.

2.6.1 Technical parameter

Press <1> to enter interface of technical parameter page, as follow picture,

```
TECHN  Punching height  2.00 mm
IC     Mid Position    20.00 mm
      Dock Position   120.00 mm
      Z Range        999.00 mm
1/5
```

The define of parameters as follow,

Parameter	Description
Z range	Set z range. Immediately stop when exceeding the travel during running, and give an alarm of Out of Z range.

Dock position	Set the target location of the follower after completely processing the program.
Mid position	Set a coordinate, and move to the coordinate through press the arrow button on the follower operation panel.
Punch height	Set the spacing distance between follower and board during punching movement.

When the cursor selects the parameter of “aligning position”, “stopping coordinate” or Z axis travel, there will be one more menu for <1>. And press <1> to set the current parameters jog mode.

Press arrow button for the following page, and continue to set process parameters. The second page is shown as below,

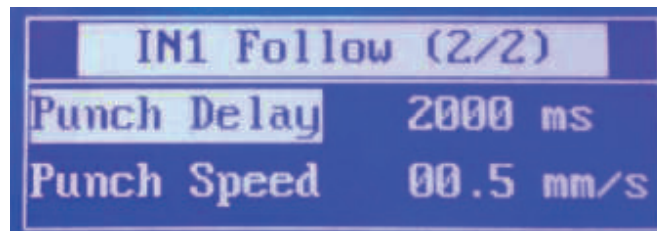
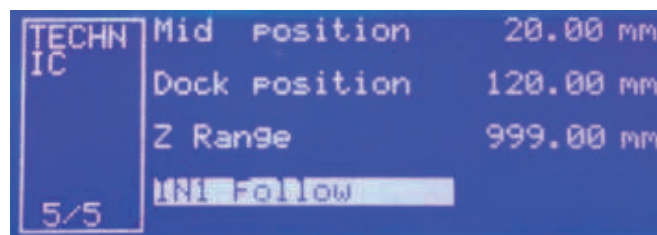

These parameters are mainly used in I/O control mode. These parameters will not take effect in Ethernet control mode.

The descriptions of parameters as follow,

Parameter	Description
INI following mode	When input port1 is effective, direct following mode is used, that is, punching-delay-following.
Punching delay	Delay time during punching
Progressive speed	Speed when progressively follow to the cutting height

When dropping to the punching position, output port 4 will give a 200ms of effective signal. When dropping to the cutting height, output port 1 will give a constant effective signal.

2.6.2 Speed parameters

Press <2> to enter the interface of Speed Parameters, as below,

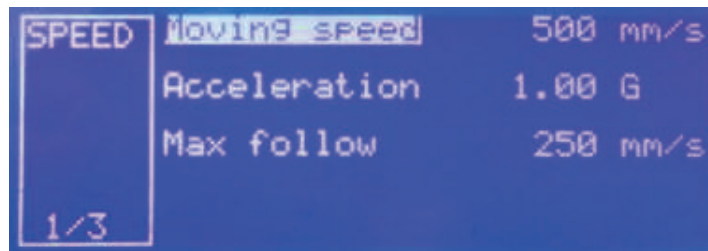

The descriptions of parameters as below,

Parameter	Description
Moving speed	Up/Down speed of follower, the suggested setting is that the servo motor should run close to rated point, so as to improve efficiency and ensure stable running of system.
Acceleration	Set the acceleration of follower for following and moving
Maxfollow	The max following speed, it depended on acceleration and the type of the nozzle. The value increase with the increase of acceleration, and becomes higher with the higher capacity-sensitive nozzle.

2.6.3 Origin Parameters

Press <3> to enter the interface of Origin parameter,

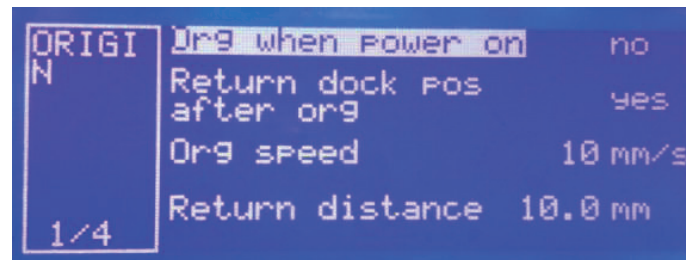

Definition as follow,

Parameter	Description
Org when power on	Set whether to automatically reset after power-on, and set the option to be Yes after debugging
Return dock pos after org	Set whether to go back to the set dock position after completing reset.
Origin speed	Set the fast movement speed to go back to the origin
Return distance	Set the return distance after touching the origin switch. This location is coordinate zero.

2.6.4 Jog Parameters

Press <4> to enter the interface of Jog parameters,

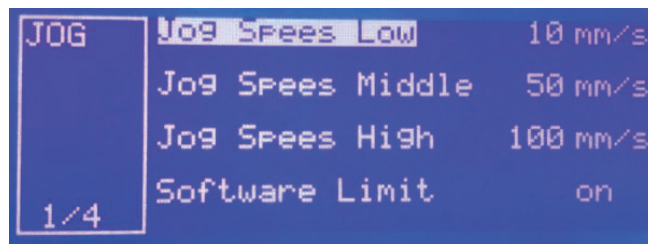

Description as follow,

Parameter	Description
Jog speed low	Set the speed of Gear L during jog movement.
Jog speed middle	Set the speed of Gear M during jog movement
Jog speed high	Set the speed of Gear H during jog movement.
Software limit	Determine whether or not to enable the soft limit while setting jog. If used, the soft limit should not jog to the position of negative coordinate or below the following height, so as to avoid hitting the limit or board during jog movement. Soft limit protection function only becomes effective on the main interface.

Only the Jog function on the interface of <Test> is open-loop controlled. The jog function on the functional testing interface will not be affected when encoder signal is abnormal.

2.6.5 Mechanical Parameters

Press<5> to enter the interface of mechanical parameter,

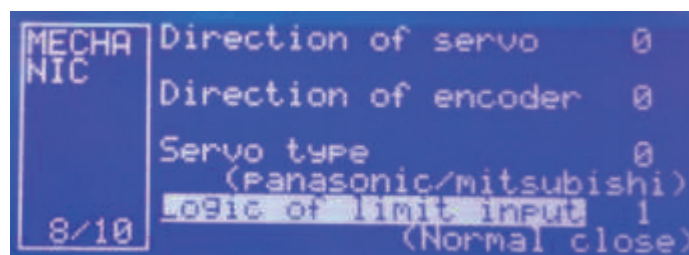
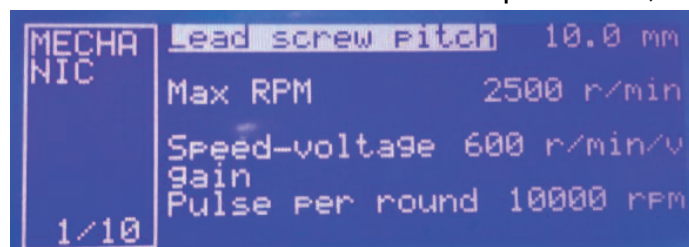

The description of parameters as follow,

Parameter	Description
Lead screw pitch	Set the travel of the transmission mechanism per revolution, such as screw pitch(lead). In theory, the bigger the screw lead, the faster the z axis runs, and it is suggested to use ball screw pitch of 5mm.
Max RPM(rotate speed per minute)	Set the allowable upper limit of rotational speed of servo motor according to the characteristics of motor and load. Generally, not exceed 4500 rev/min.
Speed voltage gain	Set the actual rotation speed corresponding to each volt. The speed should be consistent with the parameters in the driver, and the suggested value is 500 rev/min corresponding to each volt.
Pulses per round	Set the number of pulses fed back by the encoder of servo motor per revolution. The number should be consistent with the parameters in the driver.
Direction of servo	Set the rotation direction of servo.
Direction of encoder	Set the direction of pulse feedback of encoder.
Servo type	0 represents the servo of panasonic A5, Mitsubishi J3 series, Scheider Lexium23D or FujiA5. 1 represents the servo of Yaskawa Σ -V or Delta ASDA series. 2 represents the servo of Teco JSDEP series. The principles of zero-speed clamp, logic of input and output signals and system control parameters are different when the servos are different.
Logic of limit input	Set the logic of limit input port IN5-6 (0: normally open/ 1:normally closed).
Logic of general input	Set the logic of universal input port IN1-4 (0: normally open/ 1:normally closed).
IO control mode	If it is set to be 0, the follower will move down when IN1 is enabled, while the follower will shut when IN1 is disabled. If it is set to be 1, after IN1 become disabled, the follower can move up only after setting IN3 to be enabled.(The parameter is ignored when using network communication)

2.6.6 Network setting

Press <6> enter the interface of Network setting,

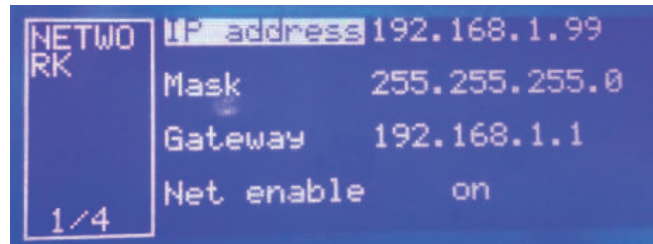

2.6.7 Alarm setting,

Press <7> to enter interface of Alarm setting.

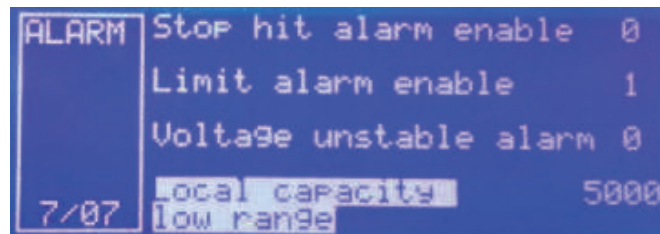
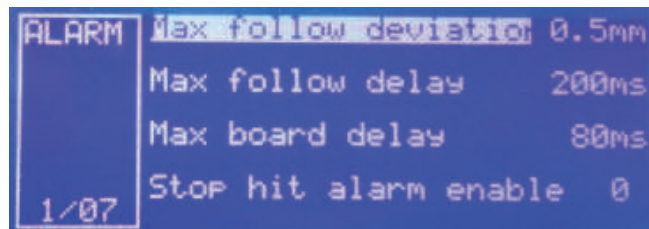

Parameter	Description
Max follow deviation	It is the maximum allowable following error of CHC-1000. After the cutting head is in place, the controller will give an alarm for too large following error if the following error exceeds the set alarm value due to the movement over the plate boundary or severe vibrations of board
Max follow delay	Set the filter time of following error alarm. The bigger the value, the slower the response and the stronger the ability to filter out interference.
Hit board delay	When the follower hits the board and the duration reaches the time limit, the follower will automatically move up for protection and output alarm signal.
Stop hit alarm enable	This parameter indicates if hit board alarm is active when the follower is in stop state. It is safer when the value equals 1. And when need to adjust the center of laser by stick adhesive tape, or when you do not want the controller always alarm in no plastic film, it is convenient to set to 0.

Limit alarm	When it is set to be 1, upper and lower limit alarm function will be started. The follower will automatically move up when encountering upper/lower limit and then give an alarm signal. When it is set to be 0, alarm function is disable.
-------------	---

2.6.8 Edge setting

Press <8> to enter interface of edge setting.

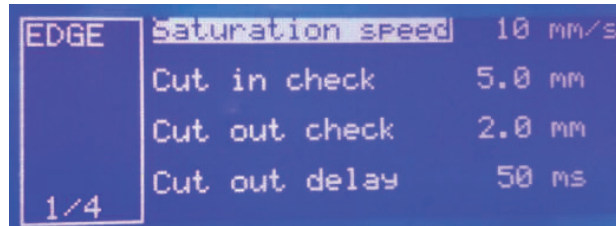

Parameter	Description
Saturation speed	The max speed to follow down after head cutting out of board to prevent deep drop damage.
Cut in check	When check the H is lower than this parameter, the head start follow.
Cut out check	If it is checked that H position is the larger than cut"cut out check" and last more than "cut out delay".
Cut out delay	
Height	Through cut height: set the Z position to locate to before following.

2.7 Interface of Advanced setting

On the main interface, press<4> to enter the interface of advanced settings,

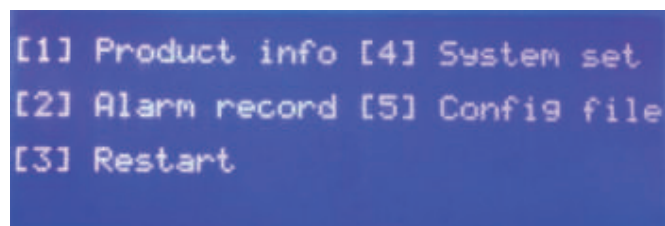

2.7.1 Product Information.

Press <1> to enter the interface of product information,

```

Ver: V3.40      (2D)      0
ID: 201605056604  [1] Register
Expiration: Foreve
CurrentTime: 2016-06-06 17:19:57

```

User can check follow information on this page.

Information	Description
Version	For example, V3.40 represents version of 2D for plate, 3 means for 3D
ID number	CHC-1000 global only serial number
Expiration	The remaining time for CHC-1000, such as 30 days,
Current Time	CHC-1000 current internal date.

Update of CHC-1000 software as follow,

```

Input 20 Register Code
S/N: 74B3722522898AF2
ID:

```

2.7.2 Alarm information

Press <2> to enter the interface of alarm information.

```

Z+ sensor enable      04/20 09:33:00
Hit board             04/20 10:21:10
Sample capacity large 04/20 17:00:01
[F1] CLEAR           03/20

```

It is a record of previous alarm events.

2.7.3 Restart

User can press <3> to restart CHC-1000 controller, this operation is equal to that the system is powered down and then powered on. Users can first insert USB disk to CHC when they want to update the program, and complete the update with restart function, which can avoid the trouble to power down and then power on this system.

2.7.4 System setting

Press <4> for system setting, then input password:

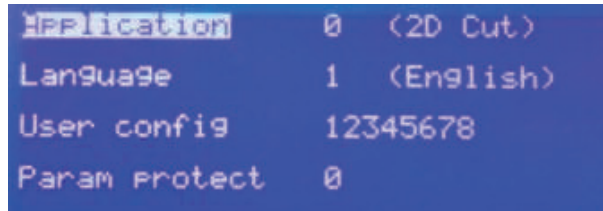
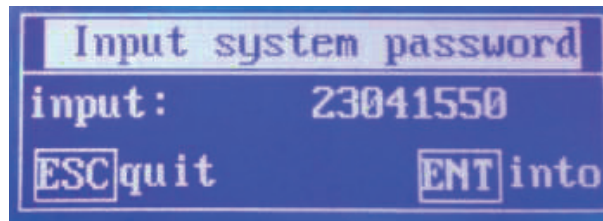

Parameter	Description
Application	0: plate cutting, 1: 3D cutting
Language	0: Chinese, 1: English
User configuration	Special customization function
Parameter protect	0: parameters are not encrypted. 1: parameters are encrypted. Users need to enter the password if they want to modify the parameters. Password:

2.7.5 Config file

Press <5> to enter config file interface, as follow,

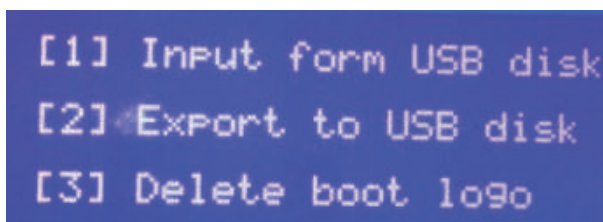

The function of configuration file includes,

- Copy parameter of specify machine to all same type machines.
- Make boot logo of CHC-1000,
- Back up CHC-1000 parameter.

Make notice of:

Use a USB disk with FAT/FAT32 format.

The configuration file's format is xxx.CFG. When import file from USB disk, make sure there is only one. CFG file at the root directory of the disk.

The file export to USB disk named EXPORT.CFG. If there is a file Export. Cfg in the USB disk before exporting. This file will be covered.

2.7.6 Hidden functions

Key	Functions
3	Set follow parameters
4	Real-time following error oscilloscope
5	Real-time monitor oscilloscope of capacitance
6	Capacitance-distance curve
7	Record the current capacitance
9	Start the follower of edge cutting
0	Set current z axis coordinates to be 0.

2.8 Oscilloscope

User can enter the interface of < capacitance oscilloscope> after pressing <5> on the main interface. The principle of the oscilloscope is to display capacitance value C in real time. It also displays the maximum value (MAX), minum(Min), difference between the Max and Min(DIF) and average vule(AVE) of the measured capacitance. As follow,



Please monitor the changes of capacitance while keeping the cutting head and board stationary. The bigger DIF value is, the bigger the interference is, or the more unstable the capacitance is.

User can determine the interference size in reference with the values below,

DIF value	Inteferece level
0--10	None
10--20	Very little
20--30	Little
30--50	Average
>50	Large

3 Installation Instruction



3.1 CHC-1000L package includes follow parts,

1. CHC-1000L control module, 1pc
2. Preamplifier, 1pc,
3. HF cable, 1pc,
4. Sensor signal cable, 10meters/1pc,
5. DB15 plug(pin), 1pc,
6. DB 15 plug(jack), 1pc,
7. Instruction manual, 1 pc.

3.2 Installation size

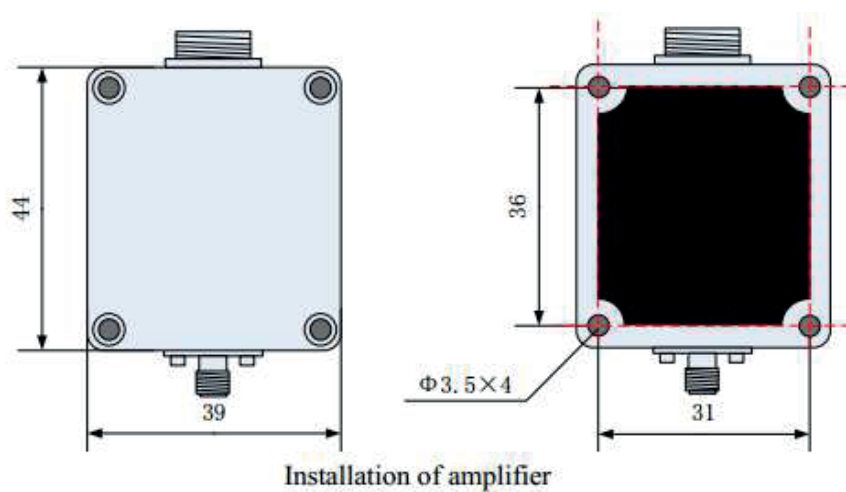

Sensor module size

Front view as follow,

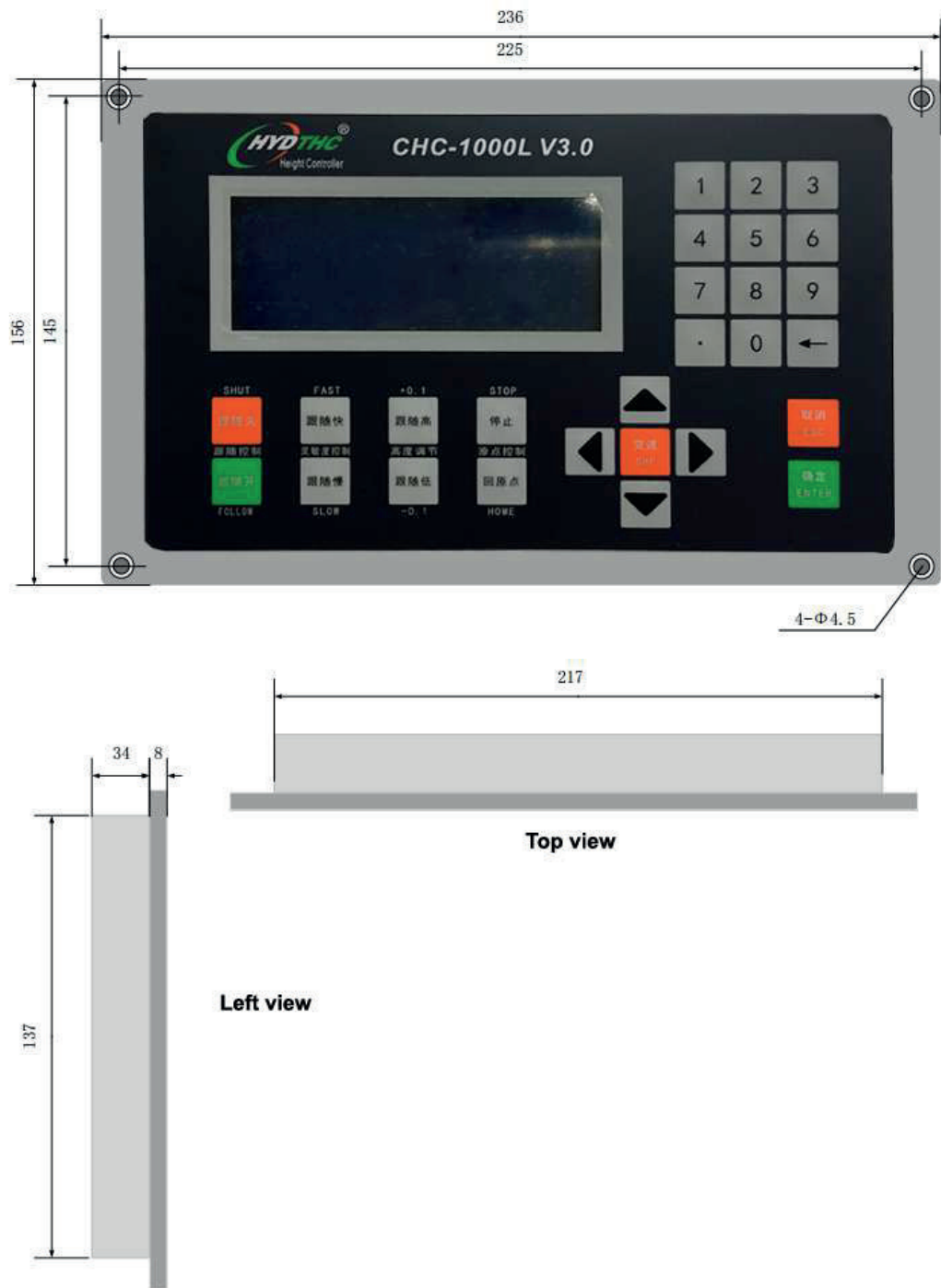

3.3 Wiring Instruction

CHC-1000 interface ports as follow,

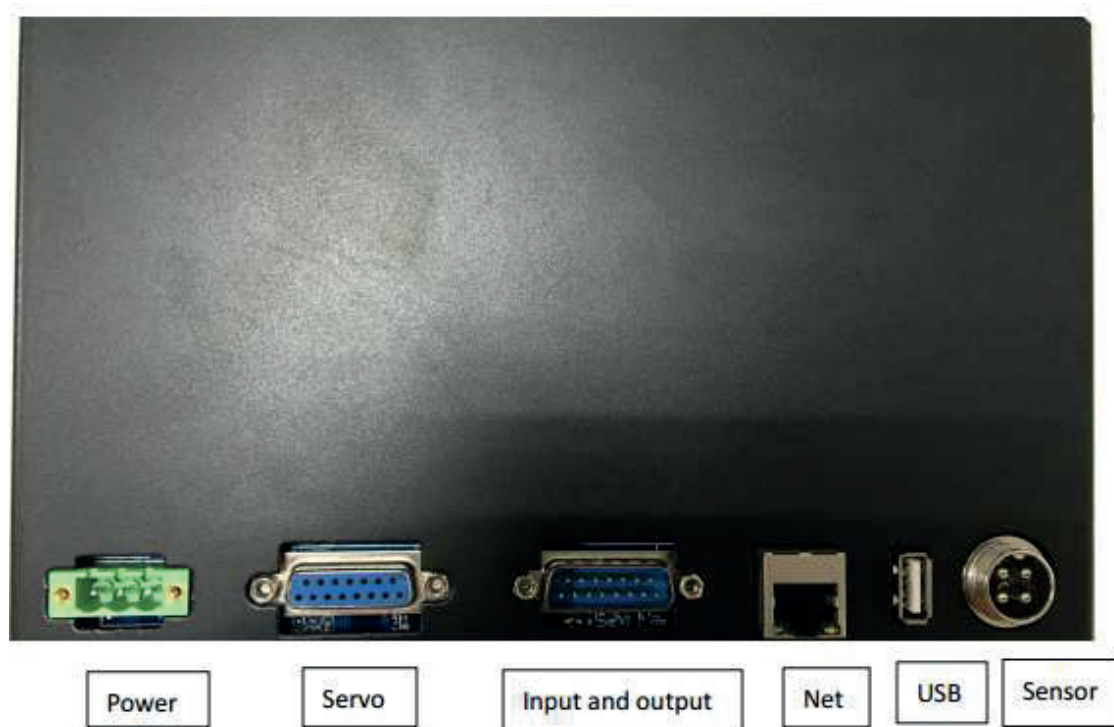

3.3.1 Power,

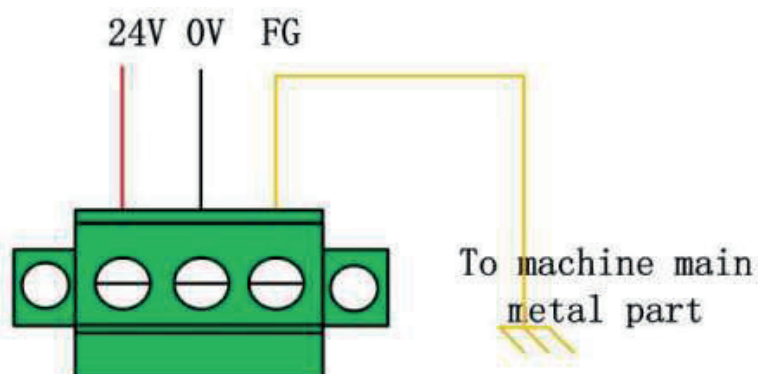

The laser machine frame(grounded to earth) is the negative electrode of the measured capacitor. To ensure the stable work of Measure Circuit, FG pin of power interface must have good connection of machine frame.The preamplifier cabinet also must have good conduction with machine frame.

The specific indicator is that D.C. impedance is always less than 10ohms, or the actual cutting height following performance may be poor.

3.3.2 Servo connection and setting.

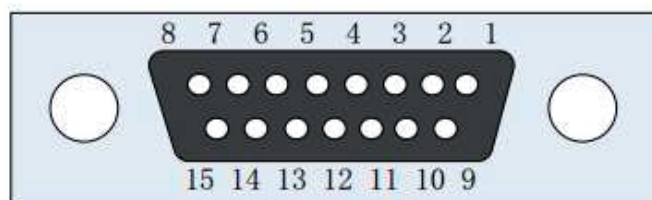

Pin	Color	Signal name
1	Yellow	DA (with an analog output of -10~10V)
2	Blue	0S (Zero speed clamp)
3	Black	A+ (Encoder A+)
4	Orange	B+ (Encoder B+)
5	Red	Z+ (Encoder Z+)
6	Green	SON (Servo on)
7	Green-black	CLR (Clear alarm)
8	Brown	24V (Power output)
9	Yellow-black	AGND (Analog ground)
10	Blue-black	0V (Power ground)
11	Black-white	(Encoder A-)
12	Orange-black	(Encoder B-)
13	Red-black	Z- (Encoder Z-)
14	Purple	ALM (Alarm signal)
15	Brown-black	0V (Power ground)

Wiring diagram of Panasonic servo

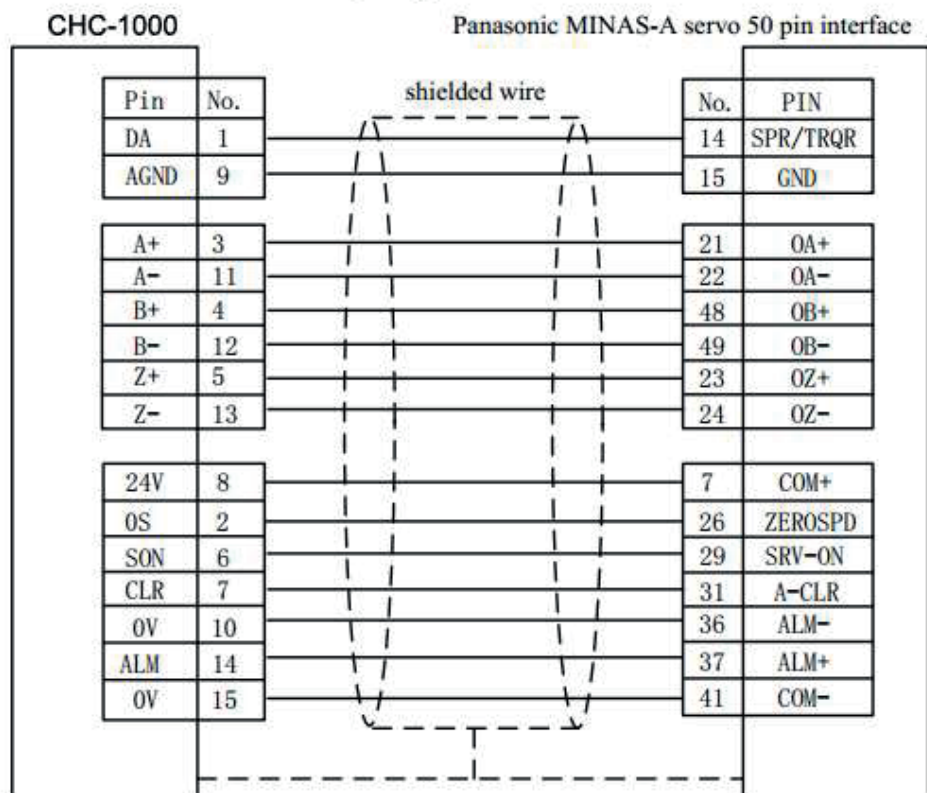

Corresponding to the wiring modes above, the servo parameters are set as follows:
Panasonic A5 series:

Parameter No.	Recommended value	Description
Pr001	1	Control mode: It must be set speed mode.
Pr002	3	Real-time automatic adjustment: The recommended setting is vertical axis mode.
Pr003	17	Servo rigidity, the recommended range is from Grade 14 to Grade 20.
Pr302	500	Input the gain of speed command.
Pr315	1	Enable zero speed clamp function.

Yaskawa servo wiring

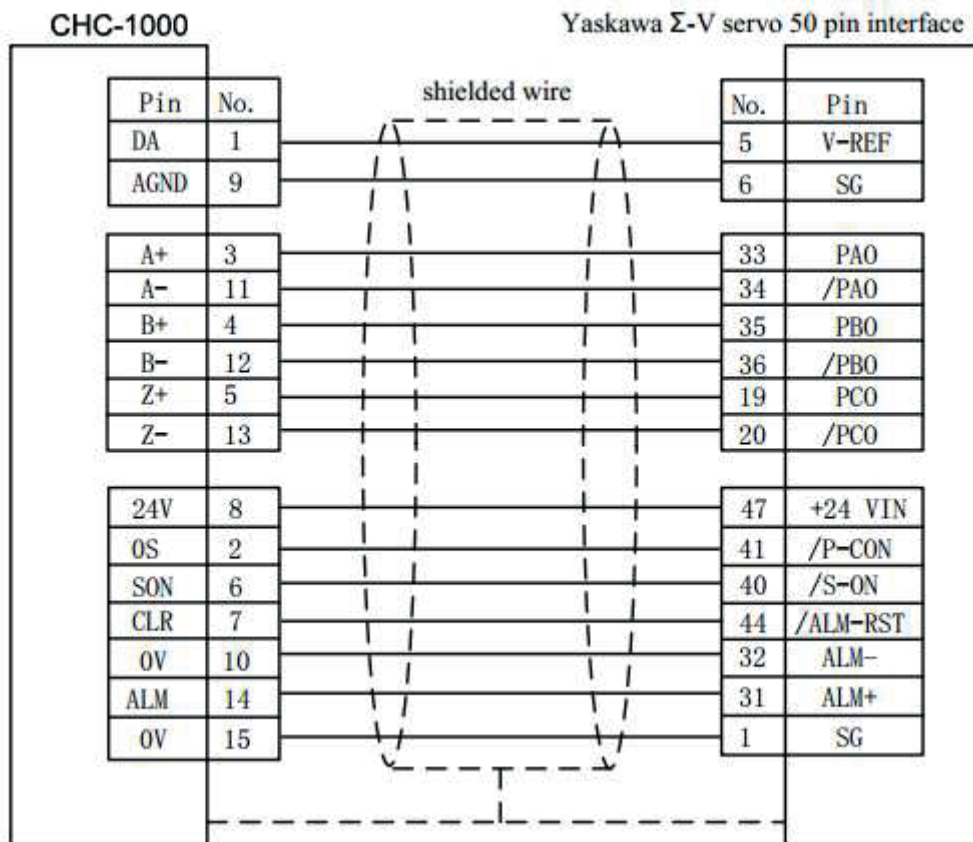

Yaskawa servo setting as follow,

Parameter No.	Recommended value	Description
Pn000	00A0	Speed control with zero-position fixation function.
Pn00B	-	Set to 0100 when using single-phase power.
Pn212	2500	Number of pulses output by the encoder per revolution. The pulse parameter of corresponding CHC-1000 per revolution is 10,000.
Pn300	6.00	The speed gain of corresponding height controller is 500 r/v/min.
Pn501	10000	Zero fixed value.
Pn50A	8100	Forward rotation is enabled.
Pn50B	6548	Reverse rotation is enabled.

Wiring of Delta servo as follow,

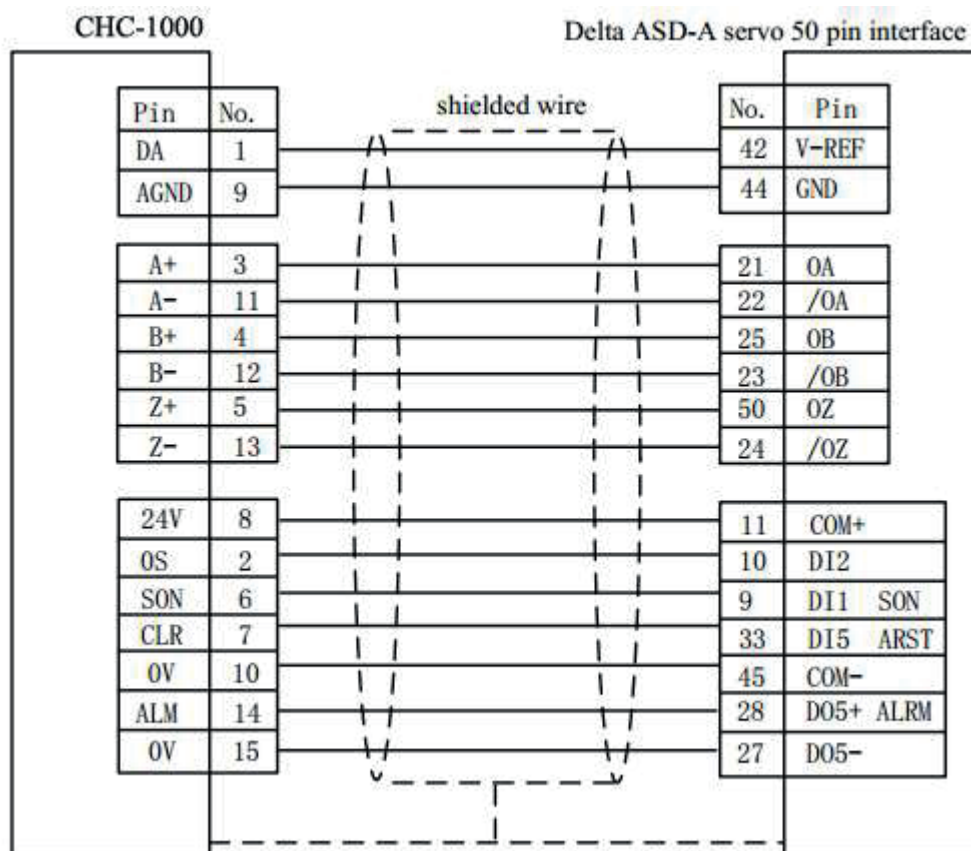

Delta servo setting as follow,

Delta ASD-A series:

Parameter No.	Recommended value	Description
P1-01	0002	Control mode: It must be set to speed control mode.
P1-38	2000	Set zero speed clamp value to the maximum.
P1-40	5000	The speed gain of corresponding height controller is 500 r/v/min.
P2-10	101	Set DI1 to SON, normally opened.
P2-11	105	Set DI2 to CLAMP, normally opened.
P2-12	114	Set speed command to external analog control.
P2-13	115	Set speed command to external analog control.
P2-14	102	Set DI5 to ARST, normally opened.
P2-22	007	Set DO5 to ALRM, normal close.

Wiring of Teco servo as follow,

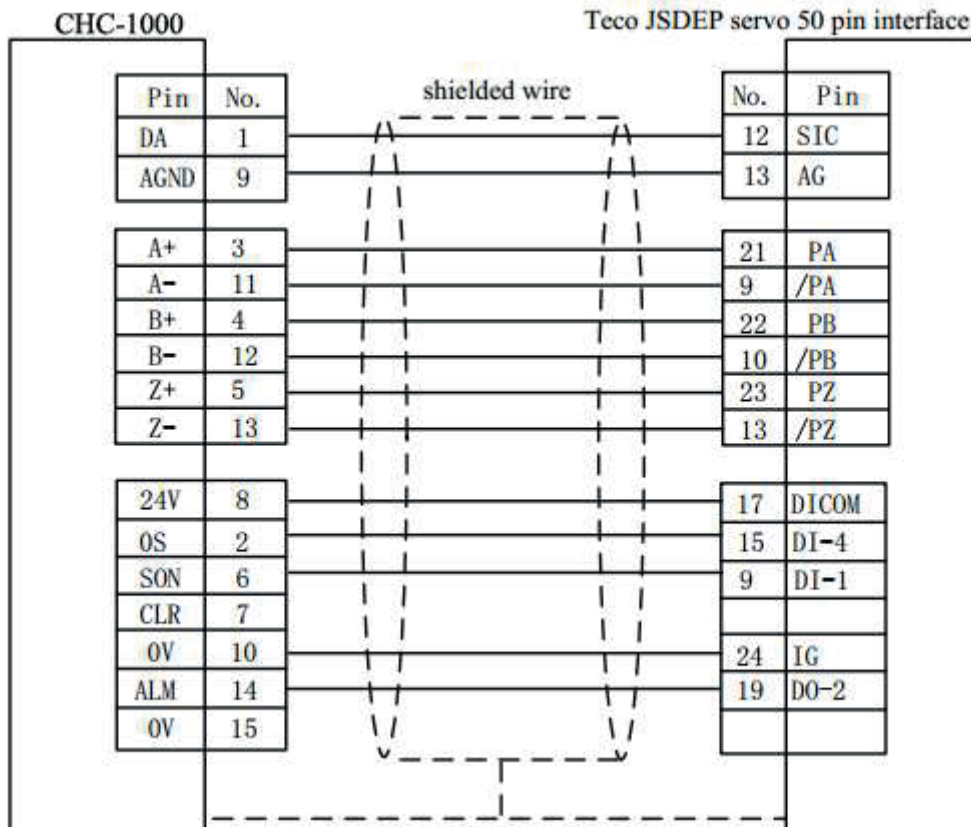

Teco servo setting as follow,

Parameter No.	Recommended value	Description
Cn001	1	Control mode: It must be set to speed control mode.
Cn002.2	1	Automatic gain. (Note: It is the parameter of the second figure of Cn002)
Cn005	2500	Number of pulses output by the encoder per revolution. The number of pulses of corresponding CHC-1000 per revolution is 10,000
Cn026	4	Rigidity. Level 4 is the default.
Sn216	4000	Speed gain. The speed gain of corresponding CHC-1000 is 400.

Wiring of Mitsubishi servo as follow,

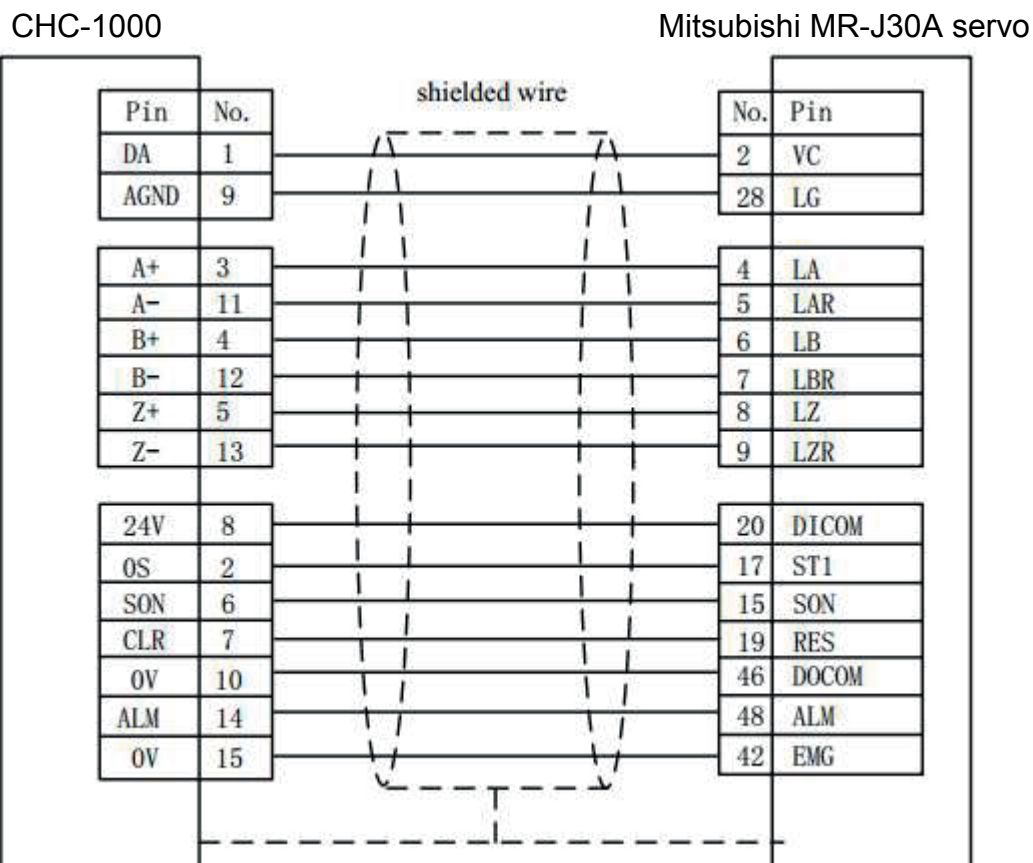

Mitsubishi MR-J30A series setting as follow,

Parameter No.	Recommnded value	Description
PA01	2	Control mode: Must be speed control mode
PA15	10000	Number of pulse output by the encoder per resolution. The number of pulses of corresponding CHC-1000 per resolution is 10,000.
PC12	5000	Speed gain. The speed gain of corresponding CHC-1000 is 500 r/v/min.
PC17	0	

Wiring of Schneider servo as follow,

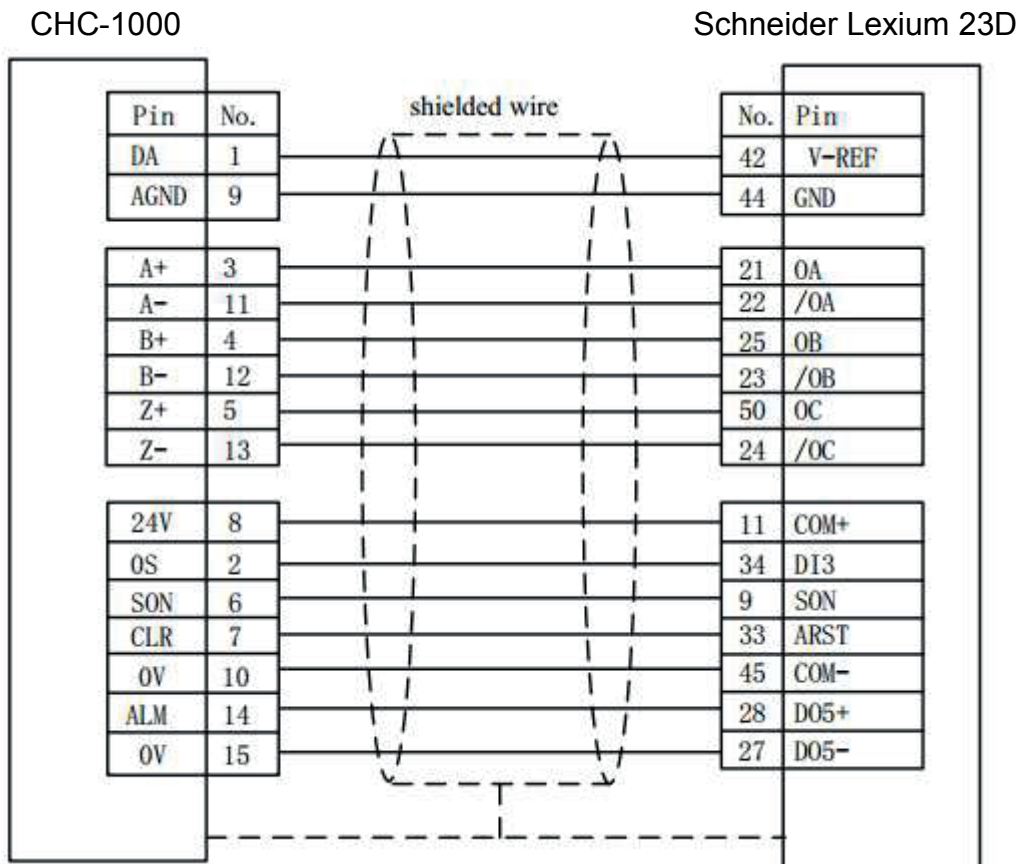

Schneider Lexium 23D servo setting as follow,

Parameter No.	Recommnded value	Description
P2-10	101	Servo IN1 function: SON
P2-11	0	Servo IN2 function: Not used
P2-13 to P2-17	0	Not use IN4 to IN8

P1-38	400	It's 40.0RPM, the zero compare value
P1-01	2	Must be speed control mode
P1-40	5000	Speed gain. The speed gain correspond CHC-1000 is 500 r/v/min
P1-46	2500	Number of pulse output by the encoder per resolution. The number of pulse of corresponding CHC-1000 per resolution is 10,000.

Wiring of Fuji ALPH A5 servo as follow,

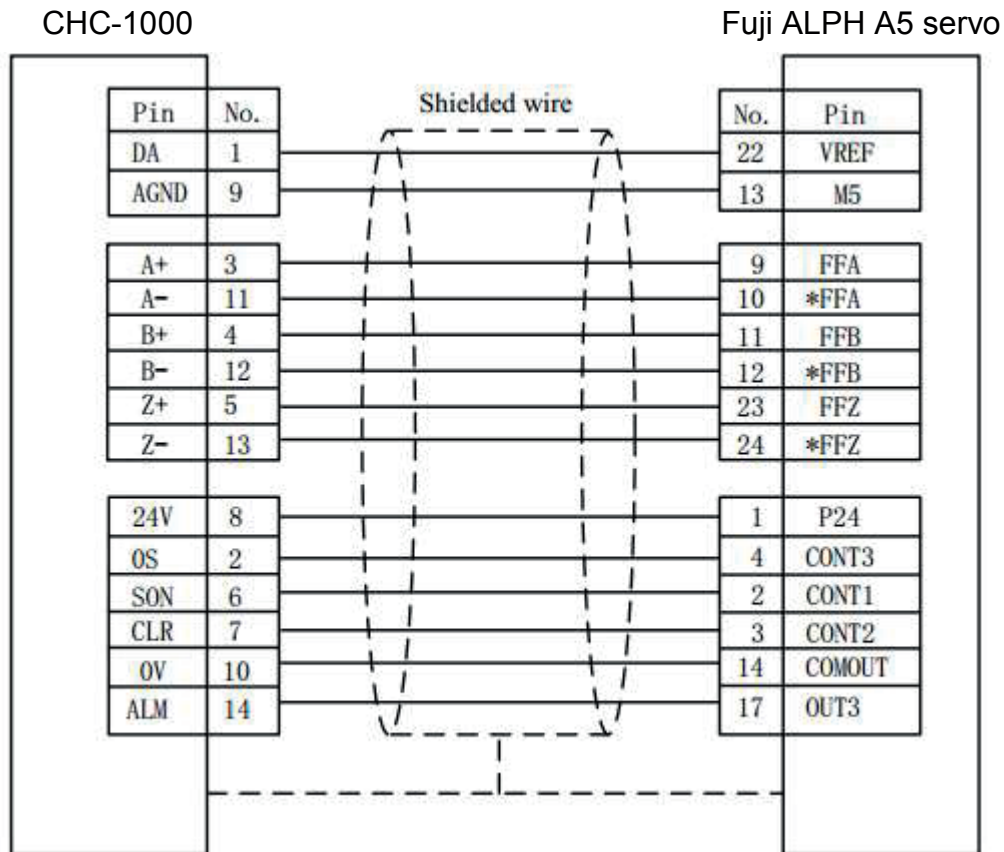

Fuji ALPH A5 servo setting as follow,

Parameter No.	Recommnded value	Description
PA-101	01	Control mode: Must be speed control mode
PA-108	2500	Number of pulse output by the encoder per resolution. The number of pulses of corresponding CHC-1000 per resolution is 10,000.
PA-115	17	Servo rigidity, the recommended range is from Grade 14 to Grade 20.
PA-303	02	Forward rotation is enabled.
PA-331	6.0	Speed gain. The speed gain of corresponding CHC-1000 is 500 r/v/min.

Wiring of SANYO servo as follow,
CHC-1000

SANYO R 50-Pin interface

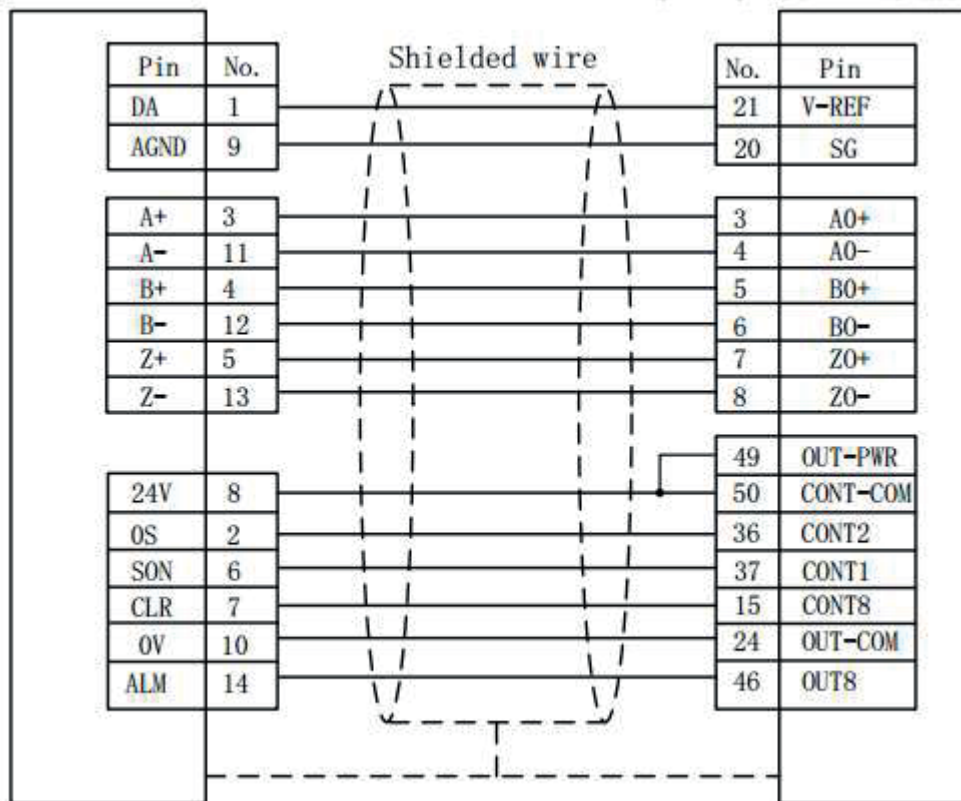

SANYO Servo setting as follow,

Parameter No.	Recommnded value	Description
SY08	01	Control mode: Must be speed control mode
Gr0.00	00	Auto tune
Gr8.25	5000	Speed gain. The speed gain of corresponding CHC-1000 is 500 r/v/min.
Gr9.00	00	Motor rotate CW enable
Gr9.01	00	Motor rotate CCW enable
Gr9.26	00	Shut down servo gain switch
GrB.13	0	
GrB.14	0	
GrC.05	2500/8192	Number of pulse output by the encoder per resolution. The number of pulses of corresponding CHC-1000 per resolution is 10,000.

3.3.3 Definition of Input/Output interface

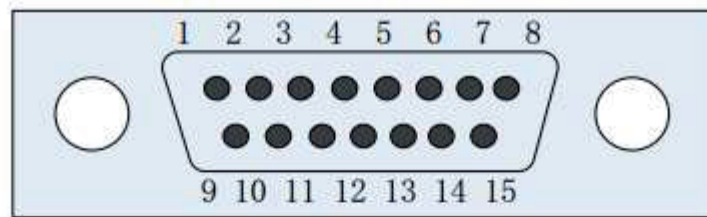

15-pin male input and output interface				
Pin	Signal definition		Pin	Signal definition
1	24V (Power output)		9	IN7(General input)
2	IN8(General input)		10	IN9(General input)
3	OUT1 (Cutting in place)		11	OUT2 (Stay to position signal)
4	OUT3 (Alarm)		12	OUT4 (Punching in place)
5	IN1 (Cutting tracking)		13	IN2 (Move to aligning coordinate)
6	IN3 (Quick lift up)		14	IN4 (Stop)
7	IN5 (Upper limit)		15	IN6 (Lower limit)
8	0V (Power ground)			

Note

1. Output ports (output 1-4) all are open drain output, and they are connected with the power ground for output.
2. Input ports (In 1—9) all are low level active input, and the input is enabled when the input ports are connected with the power ground.
3. When the cutting head reaches pierce height, Out4 output 200ms width signal. When cutting head reaches the cutting height, Out1 keeps sending out On Cutting Height effective signal.

3.3.4 Sensor module interface



- 1:Connect with pin 1 of the cable
- 2:Connect with pin 2 of the cable
- 3:Connect with pin 3 of the cable
- 4:Connect with shield of the cable

4-pin signal transmission cable of sensor can be manufactured with 3-pin shielded cable and 2 pcs 4-pin aviation sockets. It requires to connect pin 1,2,3 together, and pin4 must connected to shield layer.

3.3.5 Debugging Steps.

After installation, it needs to debug the controller as follow,

1. Set servo parameters, introduced in Servo parameters of software in previous chapter.
2. After powering on and the initialization completed, enter the parameter interface and set Mechanical parameters.
3. Go back to Main interface to check whether the travel switch is enabled. If it is an optoelectronics switch, the interface will display Upper limit is enabled when blocking the upper limit with shade. It will display Lower limit is enabled when blocking the lower limit.
4. Enter Test interface to conduct open-loop jog, and check whether the rotation direction of motor is right. If the direction is wrong, please change the servo direction parameters. And then conduct the open-loop jog again, please change the encoder direction parameters if the encoder signal is inverse(Mechanical parameters).
5. Enter Calibration interface, and conduct Servo calibration to eliminate the zero shift of servo.
6. Return to the origin manually, and turn on the power-on reset function on the interface of Reset parameters.
7. Enter Calibration interface and do capacitance calibration for the follower.
8. Modify other parameters as required after completing the steps above.

4. Alarm process and FAQ

4.1 System alarm analysis

4.1.1 Z+/Z- limit enable

When system checked Z+/Z- limit input is enabled, the alarm happens.

Reason includes,

- Z+/Z- sensor detect something

- Z+/Z- sensor is broken. Or it is used for long time, and the oil contamination and powder on the surface.

- The parameter of Limit logic can be set to normal open or normal close

- The wiring is not correct.

4.1.2 Out of Z range

When Z moves larger than range, which is a parameter of system, the alarm will be throw out. If it is wrong alaramed, take attention in the range parameter, if the system returned origin. And if the encoder feedback is correct.

4.1.3 Z- limit continue enable

When system is returning origin, it moves back when z sensor is enabled, but cant quit the z- sensor enable area, the alarm happens. Take attention if the sensor is broken.

4.1.4 Z+ limit continue enable

When system is returning origin, it moves back to positive axis, but come to the Z+ sensor enable area, the alarm happens. Take attention whether the aligning coordinate or Dock accordinate is large.

4.1.5 Servo Alarm

When system checked No.14 input ALM is enabled, which reflect the servo alarm status, the alarm is shown on the screen. The reason of servo alarm includes,

- The servo alarms.

- The Servo Type parameter is not correctly set.

- Wiring is not correct.

- Electrical system disturbs the wire.

4.1.6 Encoder moves abnormally

When system keeps in stop status, the encoder feedback value changed, there will be this alarm. The reason lead to the alarm includes,

- The axis vibrates by outside force.

- Wiring wrong, the zero speed signal does no effect.

- Servo rigidity is very low.

- The encoder wire is disturbed. The shield is needed, and should be connect to the ground. Add some wire magnet ring is better.

4.1.7 Encoder no response

The system try to move, send out speed command as voltage, but the encoder feedback value does not change at all. The alarm happens, reasons as follow,

- Wiring error,

- Servo type is wrong. Servo must have speed control mode.

- Servo parameter is not correctly set. It should be switched to speed control mode.

4.1.8 Encoder deviation large

When the difference between destination position and feedback position is too large, the alarm happens. It reflects the servo cant follow the speed command correctly. Reasons as follow,

- Encoder feedback direction is wrong. The reflective parameter should be modified.

- Wiring error or disturb make the encoder feedback wrong.

- The mechanic is stuck, the real position cant follow destination position.

4.1.9 Capacity is 0

When system cant check the capacity of the spray, the capacity value is shown as 0 on the screen. The following situation may cause the alarm.

- The spray touched the board below.

There is water in cutting head.

The local capacity of the cutting head is large, which is out of the check range of the preamplifier.

The preamplifier is broken.

Connection is not fixed.

In the internal of cutting head, the positive of capacity(Spray) is the short circle with the negative of capacity.(The frame of laser machine).

4.1.10 Local capacity small

When local capacity changes less, the alarm happens. Reasons as follow, Connection or some part is changed or moved, need to do calibration again.

Laser shoots on the spray, the temperature gets very high is short time.Man's hands cant stay on the spray.

Blow leads to the change of distance of positive pole(spray) and negative pole.(frame of laser machine.)

Connection is not fixed.

The parameter of calibration range is low and can also lead the alarm.

In 2D mode 15mm is recommended. And 10mm is recommended in 3D mode.

One of the reason is the cutting fire and electronic affects the capacity sensor when the board material is stainless steel.

If there is plastic film on the surface of steel, remove the film first. Check if the machine is connect to the ground well. The following height should be large than 0.5mm. Improve the blowing pressure.

4.1. 11 Follow devlation large

When system check the H height (the distance between spray and board) changes large in short time in follow state, the alarm happens. The relative parameter is interpreted in previous chapter. The alarm reasons as follow,

Cut out of the board. There is nothing to follow below.

Board vibrating heavily.

4.1.12 Sample capacity large

When sampled capacity is larger than the largest capacity in calibration, the alarm happens. The reason as follow,

The spray touched the board below,

There is water in cutting head.

Connection is not fixed.

In the internal of cutting head, the positive of capacity(Spray) is short circle with the negative of capacity(The frame of machine).

4.1. 13 Expiration of time.

There is no more time permitted to use this system.

4.1. 14. Battery lost locak.

When unpacked the battery of the unregistered controller, the alarm happens.

User can remove the alarm by registering the controller.

4.1. 15. Jog nearby board.

When jogging the follower near the board, the alarm happens.

4.2 FAQ

4.2.1 Obvious vibration and mechanical shock in the following movement

Amplifier cabinet or sensor FG pin connection to machine frame is poor. Machine frame is the negative electrode of the measured capacitor. When the conductivity of amplifier cabinet and machine frame is poor, the AC impedance between positive and negative electrode of the capacitor is large. Thus, the load of measured circuit varies, which may lead to larger measurement error. If good mechanical connection can not be achieved, users can add a wide wire (copper material is better) between amplifier metal cabinet to reduce AC impedance. The AC impedance of single-point connection is greater than that of good mechanical connection. It is required to make the AC impedance less than 10 ohms.

Too large servo rigidity.

Mechanical shock and obvious vibration may be caused during the movement due to too large servo rigidity. For example, it is recommended that the servo rigidity of Panasonic A5 series should not be above level 19.

Too large following speed level

Vibration may be caused during the movement due to too large following speed level. Level 3 to 7 are recommended.

Poor follower calibration

When the data stability and smoothness of capacitance and position stored in CHC-1000 is poor, vibration will be caused during the following movement. Please do follower capacitance calibration again, until the stability and smoothness becomes excellent or good.

If there is a large interference at the field, users can reduce the parameter of Servo gain coefficient accordingly.

4.2.2 The follower always hits the board during following movement.

Too small calibration range or too large Z axis speed.

The smaller the calibration range, the smaller the deceleration distance of following movement. If Z axis speed is too large and it is not reduced to 0 when the follower flows to place, overshoot will be unavoidable. The greater the Z axis speed is, the greater the overshoot is. When Z axis speed is higher than 100mm/s, it is recommended to set the calibration range to be 15mm, when Z axis speed is higher than 250mm/s, it is recommended to set the calibration range to be 20 to 25mm.

Too small servo rigidity.

Servo response may lag behind the control signals of controllers due to too small servo rigidity, and thus the follower will hit the board. For example, it is suggested that the rigidity of Panasonic A5 should not be below level 13.

Capacitance calibration

The follower will hit the board when there is a large deviation between the capacitance stored in CHC-1000 and the actual measured capacitance. i.e. the nozzle temperature increases a lot or the connection is not stable. User needs firstly find the reason, and then calibrate capacitance again after solving the problem.

No preheating.

Please preheat the amplifier for 2 to 5 minutes, and then operate CHC-1000 controller after sampling the capacitance in the amplifier becomes stable.

The locking nut of ceramic part is not connected tightly.

The locking nut of ceramic part is not connected tightly, which may lead to instable detecting capacitance.

4.2.3 The following height is different from the actual height.

No preheating

Please preheat the amplifier for 2 to 5 minutes, and then operate CHC-1000 controller. The sampling capacitance in the preamplifier may change with the changes of temperature. Please operate CHC-1000 controller after sampling the capacitance in the amplifier becomes stable.

Calibration problem

The phenomenon above often appears if the follower capacitance is not calibrated again after replacing the nozzle.

Nozzle temperature increases abnormally(above 100 degree) because the laser scatter to the nozzle or the blowing is abnormal, and thus the capacitance of cutting head changes.

The follower does not hit the board in intelligent calibration, and the actual following height is higher than the setting height.

Please do calibration after closing the intelligent check option.

4.2.4 The follower can not move up to the correct height

If the follower can not move up or the lift-up height is incorrect, users need to first observe and determine whether z axis coordinates are normal. If z axis coordinates get less obviously, it is required to first return to the origin, press repeatedly FOLLOW and SHUT, and then observe whether z axis coordinates are consistent with each other after following to the board. If Z axis coordinates continue to decrease, there may be a problem in the position feedback of the system. The reason may be that, servo motor or ballscrew and coupling slide against each other, resulting in coordinate offset.

4.2.5 Validation error, failed ARM upgrading when updating.

Update file may be infected by computer virus.

4.2.6 Follower moves up without contacting the board during calibration.

Please check the follow material is set to Metal or Nonmetal in controller.

4.2.7 How to update the system software.

Your CHC-1000L supplier shall offer the update software by email or online tool, please copy it to USB disk.

The update file must be saved under Root directory in USB disk, DO NOT save it in other existed file.

DO NOT change the update file's name.

Or CHC-1000L can not find the update file in the USB disk.

Then plug the USB on CHC-1000L, restart the controller.

During the controller start process, press the Backspace key and hold 5 seconds until get into update page.



Backspace key on operation panel.



8 800 555-63-74 бесплатные звонки по РФ

Контакты

+7 (495) 505-63-74 - Москва

+7 (473) 204-51-56 - Воронеж

+7 (812) 425-17-35 - Санкт-Петербург

purelogic.ru

394033, Россия, г. Воронеж,
Ленинский пр-т, 160, офис 149

Пн-Чт: 8.00–17.00

Пт: 8.00–16.00

Перерыв: 12.30–13.30

info@purelogic.ru